

# Electronic Expansion Valve Controller

## SEC60x series

### Manual / Installation Instructions

#### Cautions

1. This product may cause an electric shock in handling. Please do not attempt to open it with power turned on.
2. This product should be installed in a place fixed secured by a rack or panel.
3. This product can be used under the following environmental conditions:
  - Indoor
  - Pollution Degree 2
  - At an altitude of 2000m or below
4. Power input must be within the designated ranges.
5. To turn on or turn off power supply for this product, please use the circuit breaker or switch of a standard product of IEC 60947-1 or IEC 60947-3 product and install it within a close distance allowing convenient operation by user provided.
6. An output wire to be used for this product should be inflammable grade FV1(v-1 grade or above). The thickness of the wire should be AWG 20 or above (0.50mm<sup>2</sup>).
7. To prevent it from an inductive noise, please maintain the high-voltage wire and power wire separated.
8. Please avoid installing the product in a place where a strong magnetism, noise, severe vibration and impact exist.
9. When extending the sensor wire, use a shield wire and do not extend it unnecessary long.
10. The sensor wire and signal wire should be away from the power and load wires using conduits separately installed.
11. Please avoid using the product near a device generating strong high frequency noise (high frequency welding machine, high-frequency sewing machine, high-frequency radiotelegraph, high capacity SCR controller)



#### Features

- Advanced PID algorithm to ensure accurate automatic adjustment of superheat;
- Applicable for various refrigerants;
- Quick-Safe prevention of low and high superheat to ensure the system operating well at any conditions;
- Small size, rail mounting design, easy to install;
- Energy efficient, achieving the most efficient use of the evaporator.

## 1. Basic specification

### Data

Items	Description
Dimension	72(W)mm x 114(H)mm x 29(D)mm
Power supply	24Vac +10%/-15%, 50/60Hz&24Vdc
Power consumption	Max 4W at 24Vdc
Connection	XHP
Input	Pressure sensor input
	Temperature sensor input
	Digital input
Output	Relay output (30Vdc/5A)
	EEV(uni-polar) output
Operation	Temp. -10~50°C, Humidity≤90%RH
Storage	Temp. -20~60°C, Humidity≤90%RH

Model	P-Sensor Type	Description	Application
SEC601	Voltage	-00 for Basic model -R4 for model with RS485 communication	A/C & HP
SEC602	Current		Refrigeration
SEC605	Voltage		
SEC606	Current		

## 2. Related products

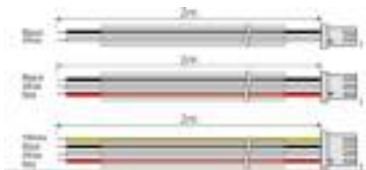
Items	Description	
Temp. Sensor	Sensor type	NTC 5KΩ
	Cable	2 m ×0.5mm
	Protection class	IP 67
	Accuracy	±0.3°C (25°C)
	Measuring range	-50 ~ 50°C
Connection kit		
		

Items	Description	
Pressure Sensor	Supply Voltage	YCQB: 5±0.25 Vdc YCQC: 10-30Vdc
	Output	YCQB: 0.5~3.5 Vdc YCQC: 4-20mA
	Measure range	0~2MPa/-0.1~1.2MPa
	Total Accuracy	±0.8% F.S.
	Protection	IP 67
	Connector Type	Solder 1/4" Thread 7/16-20UNF
	Wiring	YCQB: black, white, red YCQC: white, red
Pressure sensor to be purchased separately		

## Installation instructions for sensors

### Pressure sensor solder

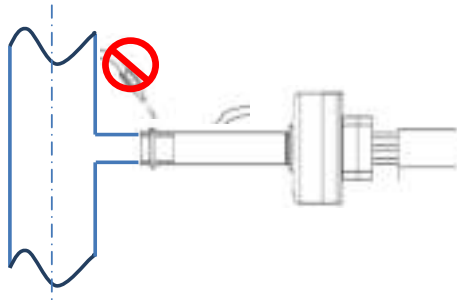

- Position the sensor copper pressure inlet in the pressure socket present on the refrigerant pipe
- Braze the sensor using specific alloy (SilFos 15)
- Don't direct the torch flame to the sensor
- Respect the maximum allowed temperature

### Pressure sensor thread

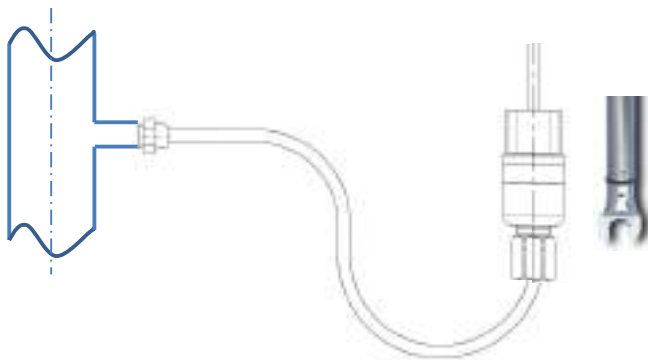

- Connect the pressure sensor with thread connection to the pressure socket directly
- or using a flexible pipe with 7/16-20 UNF thread (SAE Flare 1/4")

Size	Torque (Nm)	Torque (lbf.ft)
M14	12.7 ~ 16.7	9.3 ~ 12.2

### Installation location of Pressure Sensor

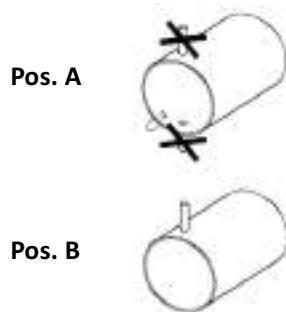

- Placed two-thirds of the riser is optimum, not more than 0.5m from the evaporator
- If a horizontal pipe is the only option, please install as shown in the illustration
- (Pos.A): Pressure measurement with liquids, The tapping point should be at the side, near the bottom of the pipe. Do not measure the pressure from the top of the pipe (where it may be affected by airlocks) or the bottom (where it may be affected by dirt)
- (Pos. B): The tapping point should be at the top so that no condensate reaches the sensor.

### Installation location of Temperature Sensor

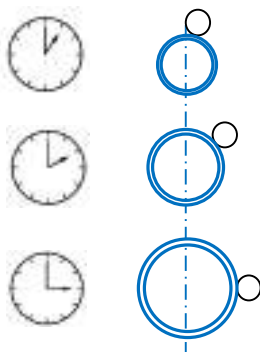

Pipe diameter: 12 – 16 mm  
1/2 - 5/8 in.

Pipe diameter: 18 – 22 mm  
3/4 - 7/8 in.

Pipe diameter: 25 – 35 mm  
1 - 1 3/8 in.

- Placed two-thirds of the riser is optimum, not more than 0.5m from the evaporator
- If a horizontal pipe is the only option, select installation location based on pipe diameter as the picture shows
- Use cable ties to fix the bulb with pipe
- Use heat-insulating material to wrap the temperature sensor to prevent external interference

### 3. Installation Notes

#### Dimensions Scheme

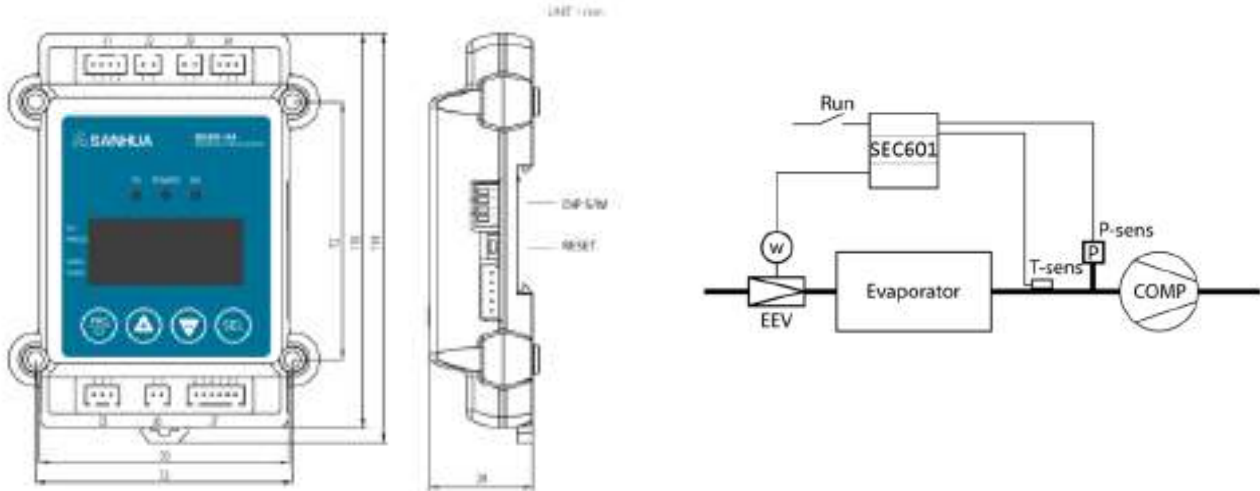







#### Connections

NO.	Function	Description	
J1	J1.1	AC/DC 24V Power input port (AC/DC 24V)	+24V Power input AC24V or DC24V+
	J1.2		-24V Power input AC24V or DC24V-
	J1.3		
	J1.4		
J2	J2.1	RUN RUN signal input port	SIG Run / Stop signal input
	J2.2		GND Signal common
J3	J3.1	RS485 RS485 comm. Input/output port	TRX+ RS485 comm. TRX+(A)
	J3.2		TRX- RS485 comm. TRX-(B)
J4	J4.1	AUX-RLY Auxiliary relay output port	N.O Auxiliary relay - Normal Open contact
	J4.2		COM Auxiliary relay - common
	J4.3		N.C Auxiliary relay - Normal Close contact
J5	J5.1	P-SENS Pressure sensor input port	Power: YCQB: +5V (red) YCQC: 10-30Vdc
	J5.2		S1 YCQB: 0.5-3.5V (white) YCQC: 4-20mA
	J5.3		GND YCQB: GND (black) YCQC: N/A
J6	J6.1	T-SENS Temperature sensor input port	S2 Temperature sensor
	J6.2		GND Temperature sensor common
J7	J7.1	EEV EEV output port	A EEV phase 1(A)
	J7.2		B EEV phase 1(B)
	J7.3		A# EEV phase 2(A#)
	J7.4		B# EEV phase 2(B#)
	J7.5		COM EEV common
	J7.6		COM EEV common

## 4. Operation method

### LED and operating button



Definition		Description
LED	SH	Display superheat
	PRESS	Display pressure
	OPEN	Display valve open ratio
	TEMP	Display temperature
	°C /bar	Display the unit of temp./pressure
		Lighting when alarming
		Flickering at manual mode
	POWER	Lighting at power up
	TX,RX	Flickering at communication
Button		Parameter change mode
		Increase or upward
		Decrease or downward
		Select and save

### Parameter setting method

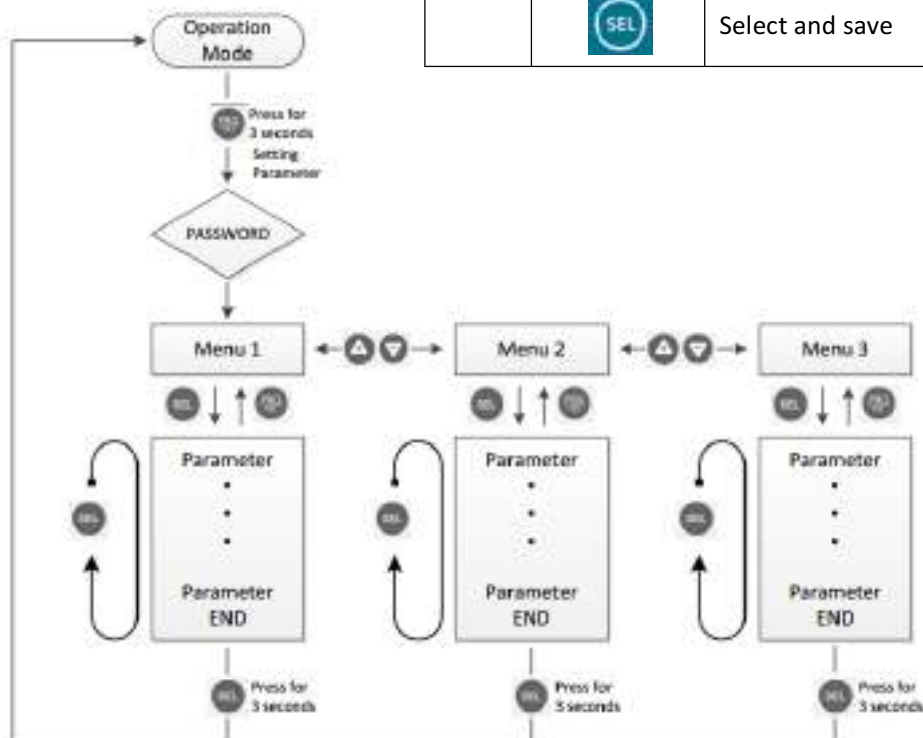





- 1) Press PRG button for 3s to setting parameters, select right password then press SEL button into the parameter setting;(if password is not correct, can only check parameter, but can't be changed)
- 2) Use UP/DOWN button move to the right menu then use SEL into the menu, select parameter by pressing SEL button;
- 3) Change the parameter value by UP/DOWN button, and press SEL to the next button;
- 4) Press SEL for 3s to save the parameters and exit the parameters setting mode.

## 5. Settings before system start

When the electric wires have been connected to the controller, the following points must be attended to before the regulation starts:

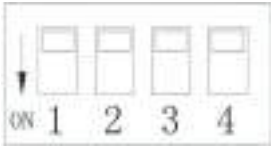
### 1) DIP SW Setting

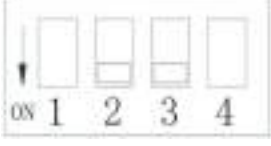
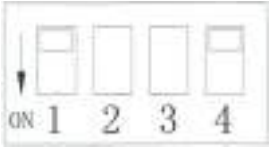
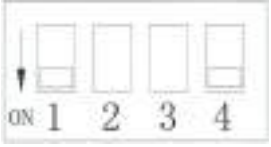
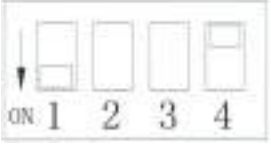
Set DIP SW switch according to the EEV information and control method.

<p>Default mode</p>  <p>In default mode, all DIP SW is OFF</p>
<p>EEV drive mode ( Depends on DIP SW2 and 3 )</p> <p>DIP SW2: OFF, DIP SW3: OFF</p> <p>1-2 PH excitation 500 pulses, 30PPS For SANHUA T/S series</p>  <p>DIP SW2: OFF, DIP SW3: ON</p> <p>2 PH excitation type, 2000 pulses, 100PPS For SANHUA O series</p>  <p>DIP SW2: ON, DIP SW3: ON</p> <p>drive by user Input at parameter 3 group</p> 
<p>Control method ( Depends on DIP SW1 and 4 )</p> <p>DIP SW1: OFF, DIP SW4: OFF</p> <p>-Superheat control -Automatic or use RS485</p>  <p>DIP SW1: ON, DIP SW4: ON</p> <p>-Drive mode -BY external signal from J5</p>  <p>DIP SW1: ON, DIP SW4: OFF</p> <p>-Manual operation -By +/-button</p>  <p>DIP SW1: OFF, DIP SW4: ON</p> <p>-Temp. control - Precise temp. control</p> 

### 2) Refrigerant type

Select refrigerant in menu 2 RFY parameter.

40062	Refrigerant	RFY
-------	-------------	-----

Currently for every controller 8 kinds of refrigerants can be chosen:

SEC601/SEC602:

22=R22, 410=R410A, 234=R1234ze, 34Y=R1234yf,  
290=R290, 404=R404A, 407=R407C, 134=R134a

SEC605/SEC606:

404=R404A, 07A= R407A, 07F=R407F,  
448=R448A/R449A, 290=R290, 452=R452A, 744=R744,  
134=R134a

### 3) EEV valve type

If the default can't match your request, you can select the right parameter in menu3.

40042	Expansion valve excitation type	EBD
40043	Expansion valve total pulse	EBP
40044	Expansion valve open pulse	EBO
40045	EEV drive speed(PPS)	EB5

### 4) Target superheat setting

Set the target superheat of your system. If the target superheat value is too small, the refrigerant may not evaporate completely; If the value is too big, the evaporator has low energy efficiency. Please set the appropriate target superheat value according to the actual system requirements.

40001	Superheat set point	SH	Default 6
-------	---------------------	----	-----------

### 5) Start open ratio and duration time

If RUN switch is turned on, valve will be opened by start open ratio. After that maintain it during start open ratio duration time and start to control.

### 6) PID parameter adjustment

According to the actual system condition, adjust the PID parameters and let the system superheat meet to target superheat.

## 6. Control mode

### 1) Superheat control (DIP SW1: OFF, DIP SW4: OFF)

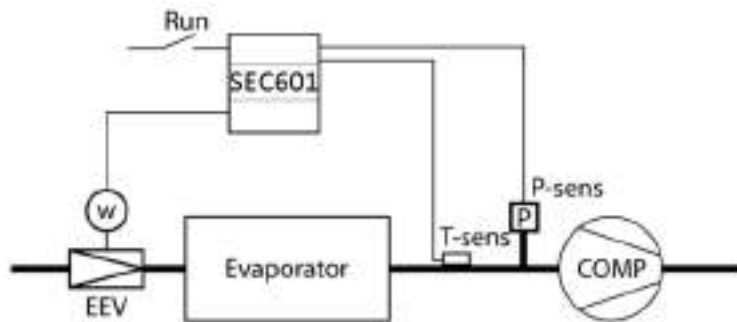

#### Application parameters

Function	CODE	Min.	Max.	Default
Superheat set-point	<i>SH</i>	0.5	30	6
Start open ratio	<i>bir</i>	0	100	0
Start open ratio duration time	<i>Sdt</i>	0	300	0
P: Proportional gain	<i>dFr</i>	0.1	99.9	3
I: Integral time	<i>IrT</i>	0	999	20
D: Derivative time	<i>drt</i>	0	999	4

### 2) Drive function (DIP SW1: ON, DIP SW4: ON)

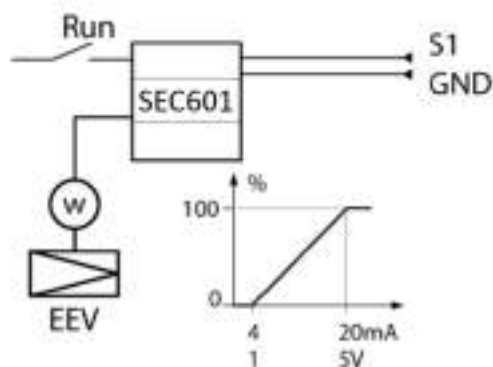

Change operation mode to drive mode, using external reference signal of 4-20mA or 1-5V to drive the EEV. Now, the RUN signal should be ON

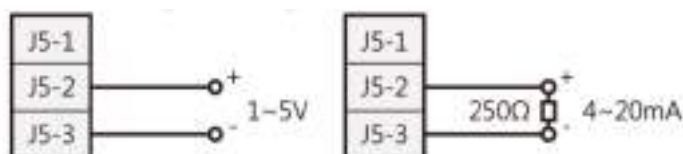

### 3) Temperature control (Hot gas bypass) (DIP SW1: OFF, DIP SW4: ON)

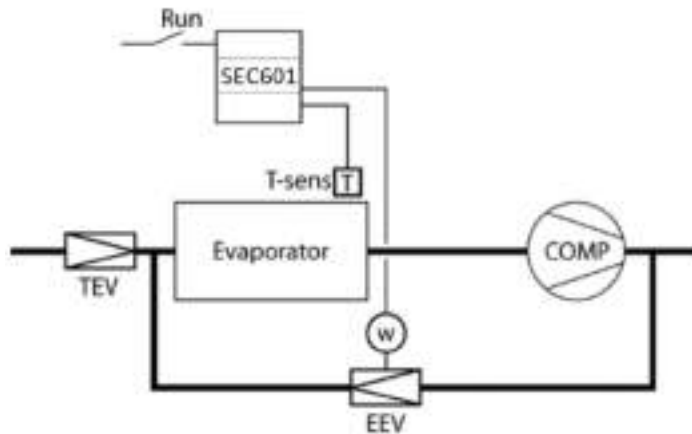

It will be used when controlling temperature of control object accurately by adjusting by-pass amount of hot gas.

#### Application parameters

Function	CODE	Min.	Max.	Default
Set point for control target *	<i>SH</i>	0.5	30	6
Start open ratio	<i>blr</i>	0	100	0
Start open ratio duration time	<i>Sdt</i>	0	300	0
P: Proportional gain	<i>dFr</i>	0.1	99.9	3
I: Integral time	<i>irt</i>	0	999	20
D: Derivative time	<i>drt</i>	0	999	4

\*Parameter will be changed and applied from superheat set point to temperature set point of control object.

### 4) Manual control mode (DIP SW1: ON, DIP SW4: OFF)

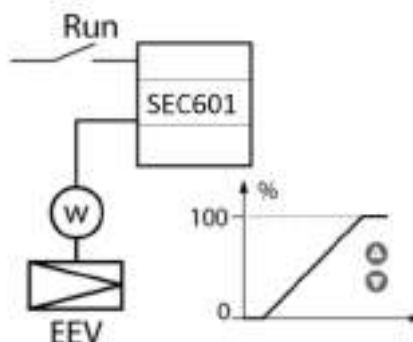

Users can maintain valve open ratio arbitrarily. Change the DIP SW switch and then press UP/DOWN button, the valve will change the open ratio as the screen displayed.

Now, all LED on the left side will be flickering.

Run signal should be ON in this mode, if the Run signal is OFF, EEV will be closed immediately.



## 7. Parameters Table

### 1) Menu 1= 1.PR

Add.	Description	Code	Unit	Step	Min.	Max.	Default
40001	Superheat set point	SH	K	0.1	0.5	30	6
40003	Start open ratio	bir	%	1	0	100	0
40004	Start open ratio duration time	Sdt	Sec	1	0	600	0
40005	P: Proportional gain	dFr	%	0.1	0.1	99.9	3
40006	I: Integral time	irt	Sec	1	0	999	20
40007	D: Derivative time	drt	Sec	1	0	999	4
40008	Low SH alarm mode	LS	0=No use 1=automatic return 2=manual return				1
40009	Low SH alarm value	LSH	K	0.1	0.5	30	0.5
40010	Low SH alarm delay time	LSd	Sec	1	1	300	15
40011	Clear low SH alarm	LSF	K	0.1	1	30.5	3
40012	MOP alarm mode	nP	0=No use 1=automatic return 2=manual return				1
40013	MOP alarm pressure	nOP	bar	0.1	-1	50	9
40014	MOP alarm delay time	nPd	Min	1	1	15	1
40015	Clear MOP alarm	nPF	bar	0.1	-1	50	8
40016	High SH alarm mode	HS	0=No use 1=automatic return 2=manual return				0
40017	High SH alarm value	HSH	K	1	10	40	30
40018	High SH alarm delay time	HSd	Sec	1	1	600	3
40019	Clear high SH alarm	HSF	K	0.1	7	37	27
40021	Freeze prevention alarm mode	Fr	0=No use 1=automatic return 2=manual return				0
40022	Freeze prevention alarm value	FrE	°C	1	-40	40	0
40023	Freeze prevention alarm delay time	FrD	Sec	1	5	200	30
40024	Clear freeze prevention alarm	FrF	°C	1	-37	43	3
40025	Select pump down function and delay time	Pd	Sec	1	0	180	-1(OFF)
40026	Pressure set-point for stopping pump down	PdP	bar	0.1	-0.5	18	0.5
40027	Pressure low limit alarm mode	LP	0=No use 1=automatic return 2=manual return				0
40028	Pressure low limit alarm value	LoP	bar	0.1	-0.8	17.7	0
40029	Low limit pressure alarm delay time	LPd	Sec	1	5	200	5
40030	Clear low limit pressure alarm	LPF	bar	0.1	-0.5	18	0.3

#### 1) Start open ratio and start open ratio duration time

If RUN switch is turned on, valve will be opened by start open ratio. After that maintain it during start open ratio duration time and then start to control.

#### 2) Detect alarm

If pressure/temperature less/more than alarm value and maintain more than the delay time, the controller will alarm and respond. (see the alarm mode introduction)

## 2) Menu2=2.PR

Add.	Description	Code	Unit	Step	Min.	Max.	Default
40061	Password	<i>PCd</i>	/	1	0	999	5
40062	Refrigerant (SEC601/SEC602)	<i>rFY</i>	22=R22, 410=R410A, 234=R1234ze, 34Y=R1234yf, 290=R290, 404=R404A, 407=R407C, 134=R134a				22
40062	Refrigerant (SEC605/SEC606)	<i>rFY</i>	404=R404A, 07A= R407A, 07F=R407F, 448=R448A/R449A, 290=R290, 452=R452A, 744=R744, 134=R134a				404
40063	Pressure sensor MAX. range	<i>PSH</i>	bar	1	0	99	12(SEC602/606) 20(SEC601/605)
40064	Pressure sensor MIN. range	<i>PSL</i>	bar	1	-1	99	- 1(SEC602/606)0 (SEC601/605)
40065	Pressure sensor offset correction	<i>PCr</i>	K	0.1	-9.9	9.9	0
40066	Temp. sensor offset correction	<i>tCr</i>	K	0.1	-20	19.9	0
40069	Jerk control ratio	<i>JEr</i>		0.1	0.1	100	100
40070	EEV open ratio upper limit	<i>oPH</i>	%	1	0	100	100
40071	EEV open ratio lower limit	<i>oPL</i>	%	1	0	100	0
40072	EEV compulsory open ratio	<i>oII</i>	/	0.1	0.1	10	1
40073	Sensor input filter time	<i>UCr</i>	%	0.1	0	100	OFF (-1)
40076	Display mode	<i>dis</i>	0=1~4 rotation 1= Superheat 2=Evaporator outlet pressure 3= Expansion valve open ratio 4= Evaporator outlet temperature 5= Saturation temperature				1
40077	Run/stop method	<i>rnt</i>	0= Always run 1= Digital input 2= Communication Run				1
40078	CommunicationID setup	<i>id</i>	/	1	1	254	1
40079	Communication speed setup	<i>bdr</i>	48(0)=4800 96(1)=9600 192(2)=19200 384(3)=38400				96

1) Jerk control ratio. Limit value of motor speed variation (Jerk Control)

2) Expansion valve compulsory open ratio.

If users want to temporarily control expansion valve by designated open ratio while controlling normally.

Default value before shipment is OFF.

## 3) Menu3=3.PR

Add.	Description	Code	Unit	Step	Min.	Max.	Default
40042	Expansion valve excitation type	<i>EBd</i>	1-2=1-2 phase excitation		2=2 phase excitation		1-2
40043	Expansion valve total pulse	<i>EBP</i>	pulse	1	10	999	500
40044	Expansion valve open pulse	<i>EBo</i>	pulse	1	0	999	30
40045	EEV drive speed(PPS)	<i>EBs</i>	10=10PPS 20=20PPS 30=30PPS 50=50PPS 80=80PPS 100=100PPS 200=200PPS 250=250PPS 500=500PPS				30

1) Users should input parameter which is suitable for characteristic of EEV. Improper value settings may

cause malfunction or valve and system will be damaged.

#### 4) Alarm mode

Code	Description	Conditions for occurrence	Way to clear
<i>PoP</i>	Pressure sensor disconnection	Disconnected	If pressure sensor normal
<i>PSt</i>	Pressure sensor short circuit	Short circuited	
<i>LoP</i>	Temp. sensor disconnection	Disconnected	If temperature sensor normal
<i>LSL</i>	Temp. sensor short circuit	Short circuited	
<i>MoP</i>	MOP alarm mode	If present pressure remains higher than set value of MOP during delay time	System check is needed. Clear if present pressure value is less than the MPF
<i>LoP</i>	Low limit pressure alarm mode	If present pressure remains lower than set value of LOP during delay time	May caused by lack of refrigerant Clear if present pressure is more than LPF
<i>HSH</i>	High superheat alarm mode	If present SH remains higher than set value of HSH during delay time	System check is needed Clear if present SH value is less than the HSF
<i>LSH</i>	Low superheat alarm mode	If present SH remains lower than set value of LSH during delay time	System check is needed Clear if present SH value is more than the LSF
<i>FrE</i>	Freezing Protection alarm	If present temp. remains lower than set value of FRE during delay time	Evaporator temp. is low, Clear if present temp. value is more than the FRF

Note: 1) Alarm which is flickering needs to reset by manual.

2) Press PGR/RST button two times quickly. Auxiliary relay (RL1) will output if alarm is occurred.

(In case of setting for alarm output relay)

## 8. Communication Protocol

### 1) Specification

Item	Description
Transmission line connection	Multiple line
Communication method	RS485 (2-wire, half-duplex)
Baud-rate	Default 9600BPS
Parity, Data, Stop bit	None, 8 data, 1 stop
Protocol Type	Modbus RTU Mode
Function Code	Read Hold Registers (0×03) /Preset Single Register (0×06)
Max. Read Word	32word
Media Type	Belden 9841/9842, LG LIREV-AMESB
Poll interval	100ms

### 2) Status of Communication table

Add.	Function	Unit	Type	S	SEC601	MMI
40073	EEV compulsory open ratio	-	Analog	INT 16	0.0-100.0	×10
40099	Reset command	-	Analog	INT 16	0:OFF	1:ON
40101	Run/Stop input	-	Analog	INT 16	0:Stop	1:Run
40102	Operation status	-	Analog	INT 16	Refer to below bit	
Bit0	Operation status of EEV	-	Digital	bit	0:OFF	1:ON
Bit1	Aux. relay output	-	Digital	bit	0:OFF	1:ON
40110	Alarm status	-	Analog	INT 16	Refer to below bit	
Bit0	Press. sensor disconnection	-	Digital	bit	0:OFF	1:ON
Bit1	Press. sensor short circuit	-	Digital	bit	0:OFF	1:ON
Bit2	Temp. sensor disconnection	-	Digital	bit	0:OFF	1:ON
Bit3	Temp. sensor short circuit	-	Digital	bit	0:OFF	1:ON
Bit4	MOP alarm	-	Digital	bit	0:OFF	1:ON
Bit5	Low limit pressure alarm	-	Digital	bit	0:OFF	1:ON
Bit6	High superheat alarm	-	Digital	bit	0:OFF	1:ON
Bit7	Low superheat alarm	-	Digital	bit	0:OFF	1:ON
Bit8	Freezing Protection alarm	-	Digital	bit	0:OFF	1:ON
40111	Present Superheat	K	Analog	INT 16		×10
40112	Present saturation temperature	℃	Analog	INT 16		×10
40113	Present pressure	bar	Analog	INT 16	-1.0~1.0	×10
40114	Present temperature	℃	Analog	INT 16	-100.0~100.0	×10
40116	EEV open ratio	%	Analog	INT 16	0.0~100.0	×10